

Data Sheet



Article number: 03446280

Description: Fluro Heavy Duty Spherical Plain Bearing GE 280 GW-2RS
Hole Ø280

Note: 280

Measures

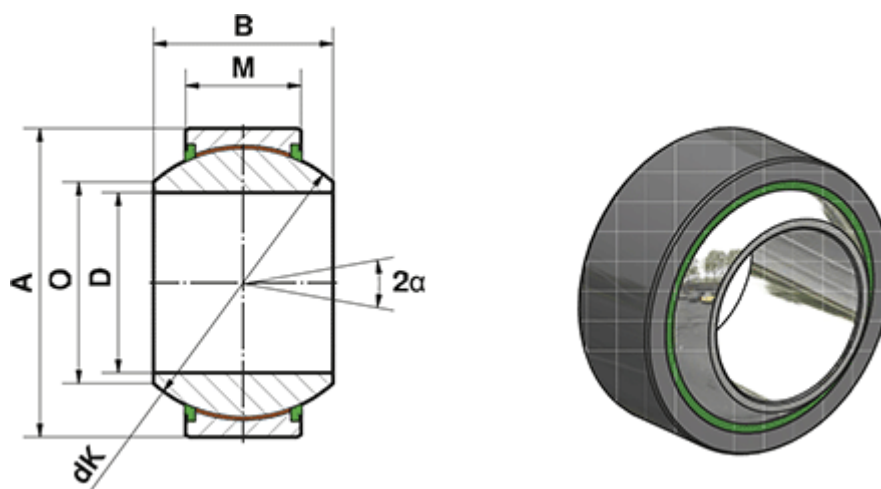

= -	Dynamic load C (kN) = 10800
= -	M = 120
= -	O = 310.6
A = 430	Static load C0 (kN) = 18000
a (degrees) = 15	Weight (g) = 96500
B = 210	
D = 280	
dK = 375	